

Varenummer: 0108049
 Beskrivelse: Seeger låsering JK 32 DIN 984

Mål

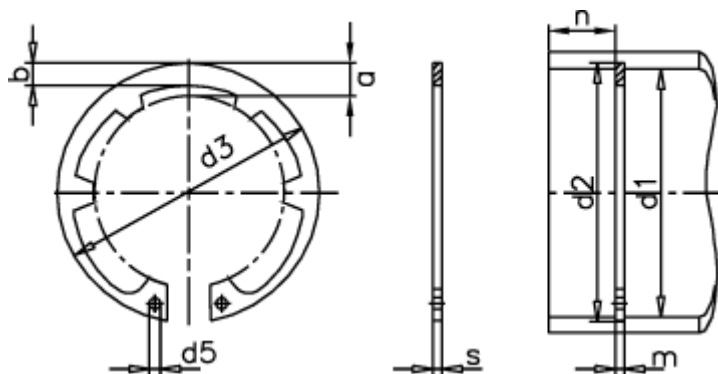

a max	= 5.1	d5 min	= 2.5	s	= 1.20
AN mm ²	= 87.9	FN kN	= 14.6	t	= 0.85
Antal takker	= 6	FRg kN	= 4.7	Tang	= ZGJ-2
b	= 3.3	FR kN	= 13.8	tol	= -0.06
Betegnelse	= JK 32	g	= 1.0	tol	= +0,50-0,25
d1	= 32	K kN-mm	= 26.6	tol	= +0,25
d2	= 33.7	m min	= 1.30	vægt kg/1000	= 2.50
d3	= 34.4	Nominal træk	= 2.5		